

SKÓLASTOFA

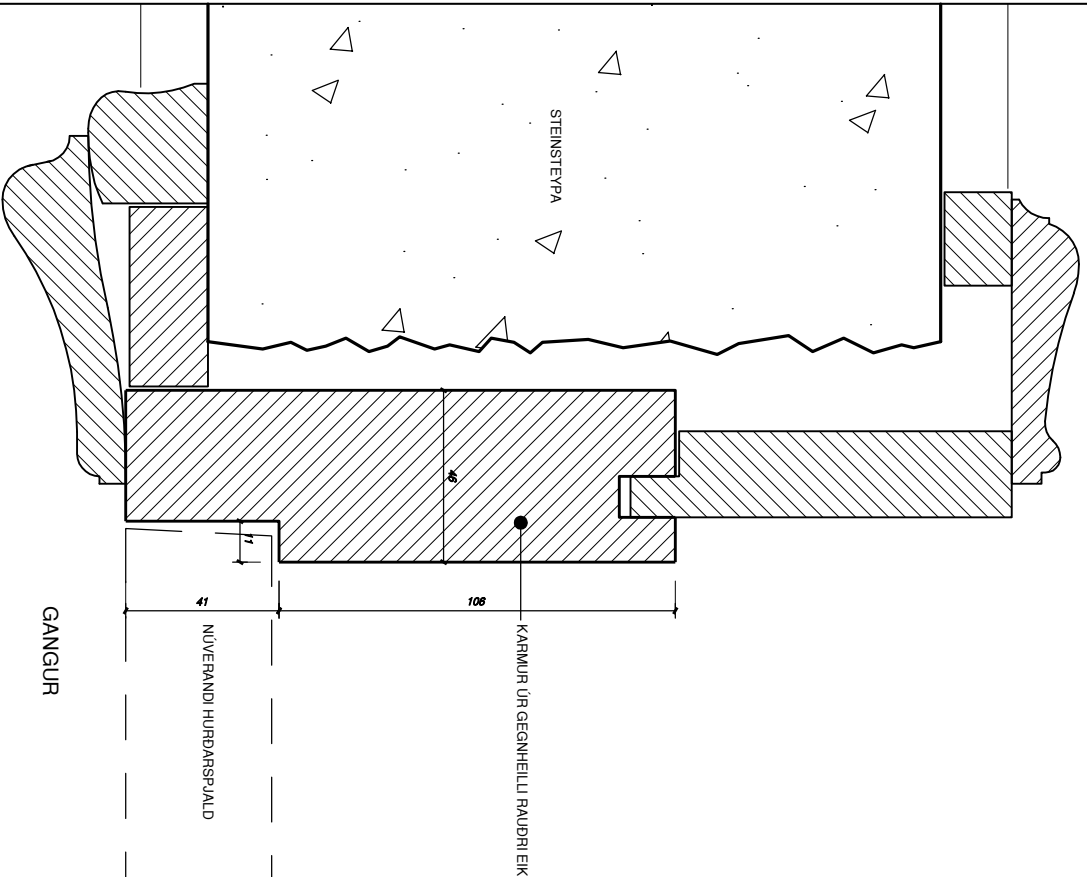

A 32/02 NÚVERANDI FYRIRKOMULLAG LARÉTTI SNID MÁL 1:1

SKÓLASTOFA

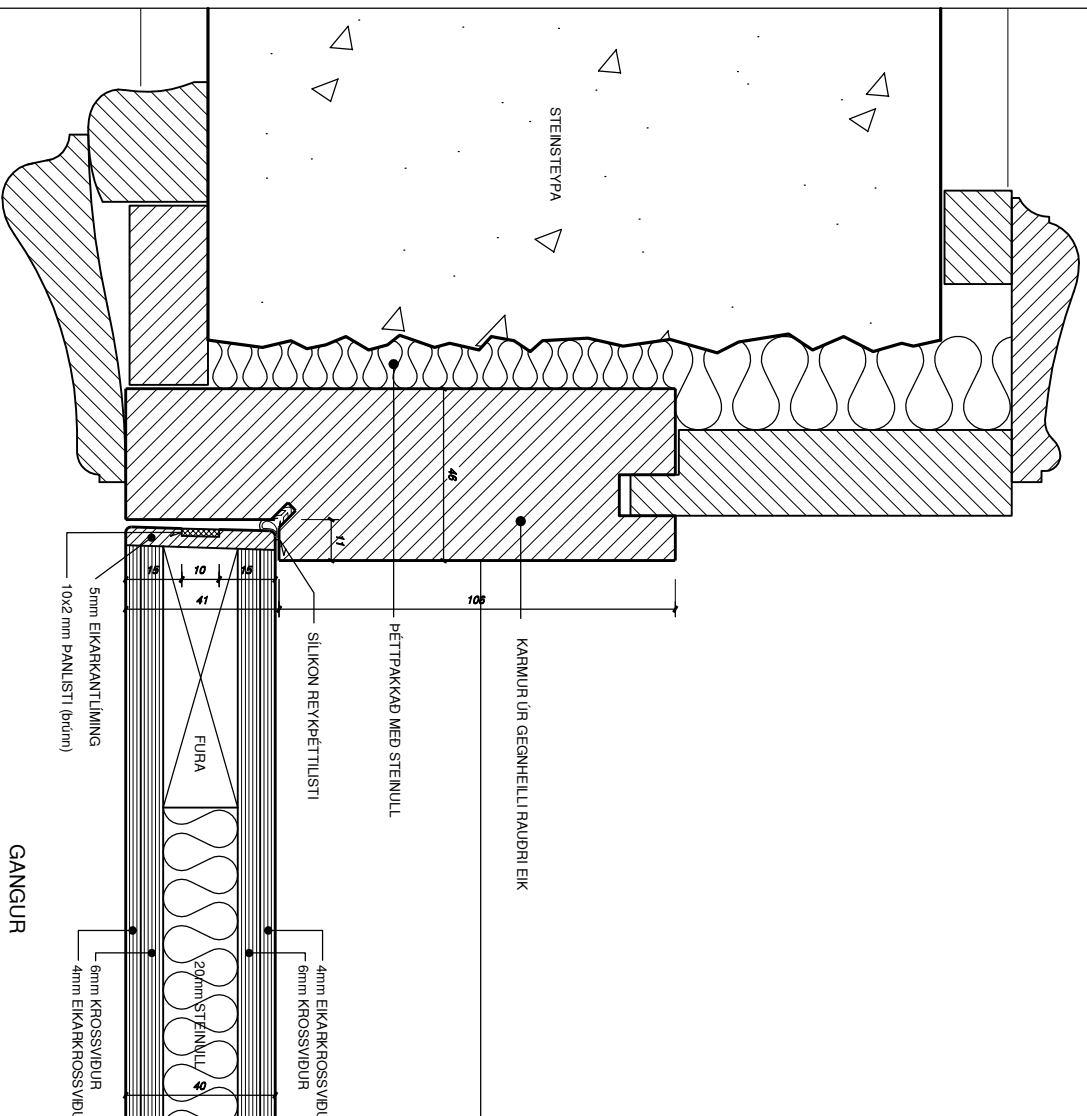

A 32/02 NYTT HURDARSPJALD OG BRUNAPÉTTING EIC330 LARÉTTI SNID MÁL 1:1

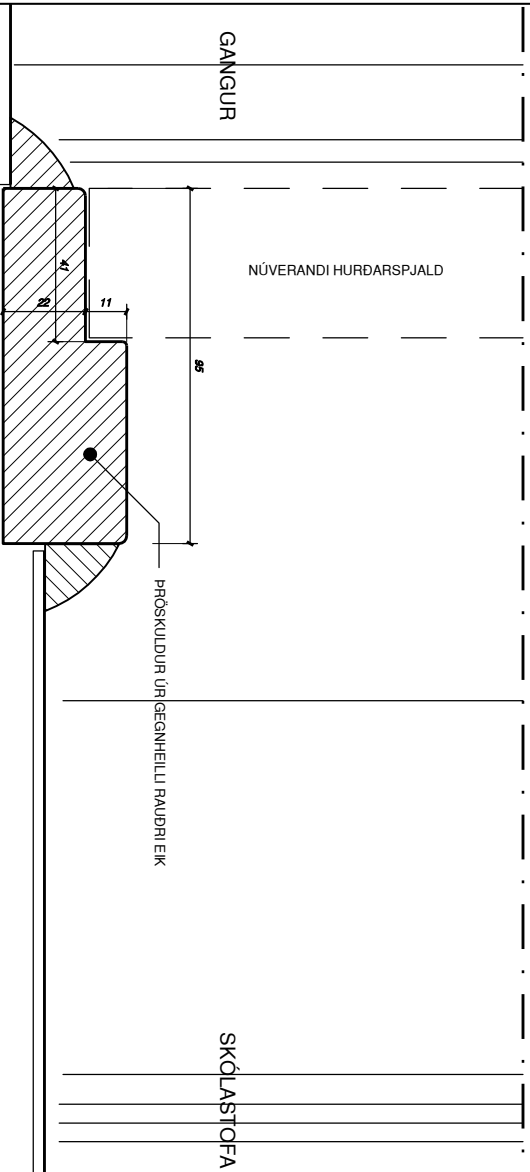

B 32/02 NÚVERANDI FYRIRKOMULLAG LÖÐRÉTTI SNID MÁL 1:1

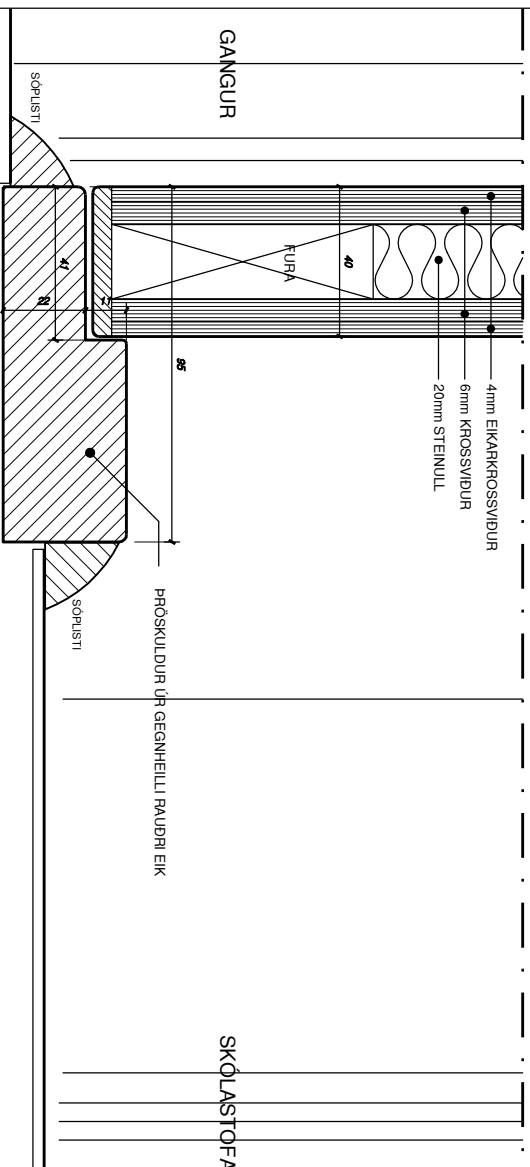

B 32/02 NYTT HURDARSPJALD OG BRUNAPÉTTING EIC330 LÖÐRÉTTI SNID MÁL 1:1

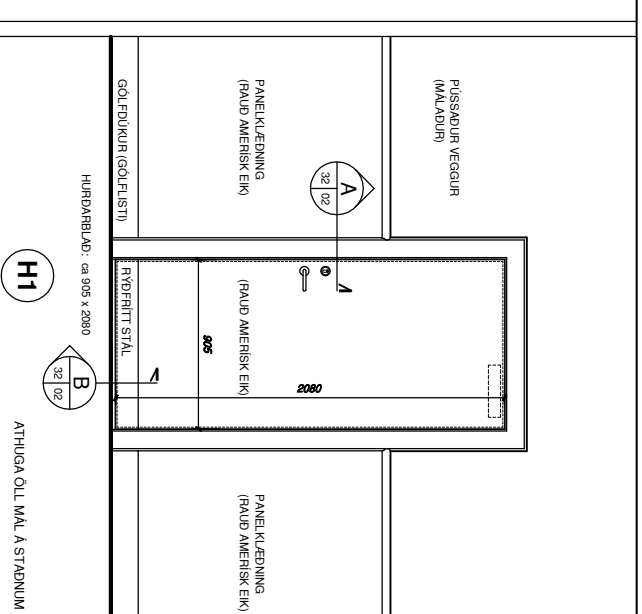

H1 HURDARBLAÐ: ca 905 x 2080 ATHUGA ÖLL MÁL Á STAÐNUM

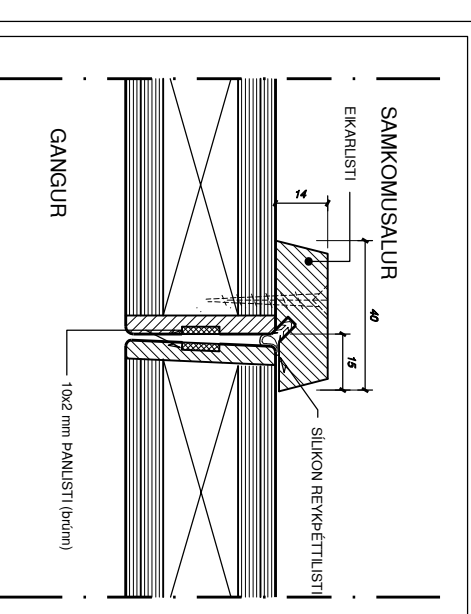

C 32/02 TVOFOLD HURD LARÉTTI SNID MÁL 1:1

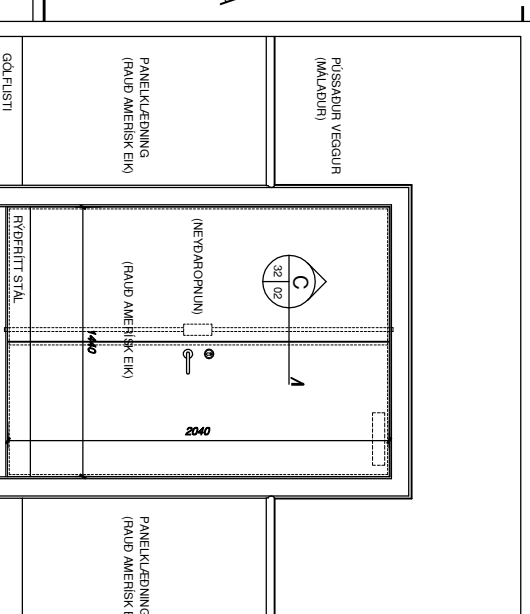

H2 ATHUGA ÖLL MÁL Á STAÐNUM

NR. FÓÐUR BREYTINGAR DÆGIS SAÐR

NR. FÓÐUR BREYTINGAR DÆGIS SAÐR

MELASKÓLI
ELDVARNARHURDIR Í ELDRI BYGGINGU

TEKINSTOFA ERLINGS G PEDERSEN
ARKITECT F.A.L. 23088-0039
GRÆNASÁVEGUR 3 - 108 REYKJAVÍK
SÍM: 590-9980 999-8014 FÁX: 590-9951

VERKHIUTI
HEITI 1:1
MÁL 1:1
DAGS 01/02 2003
ARK : 32 - 02